

SECTION II

TM 10-3930-242-24P

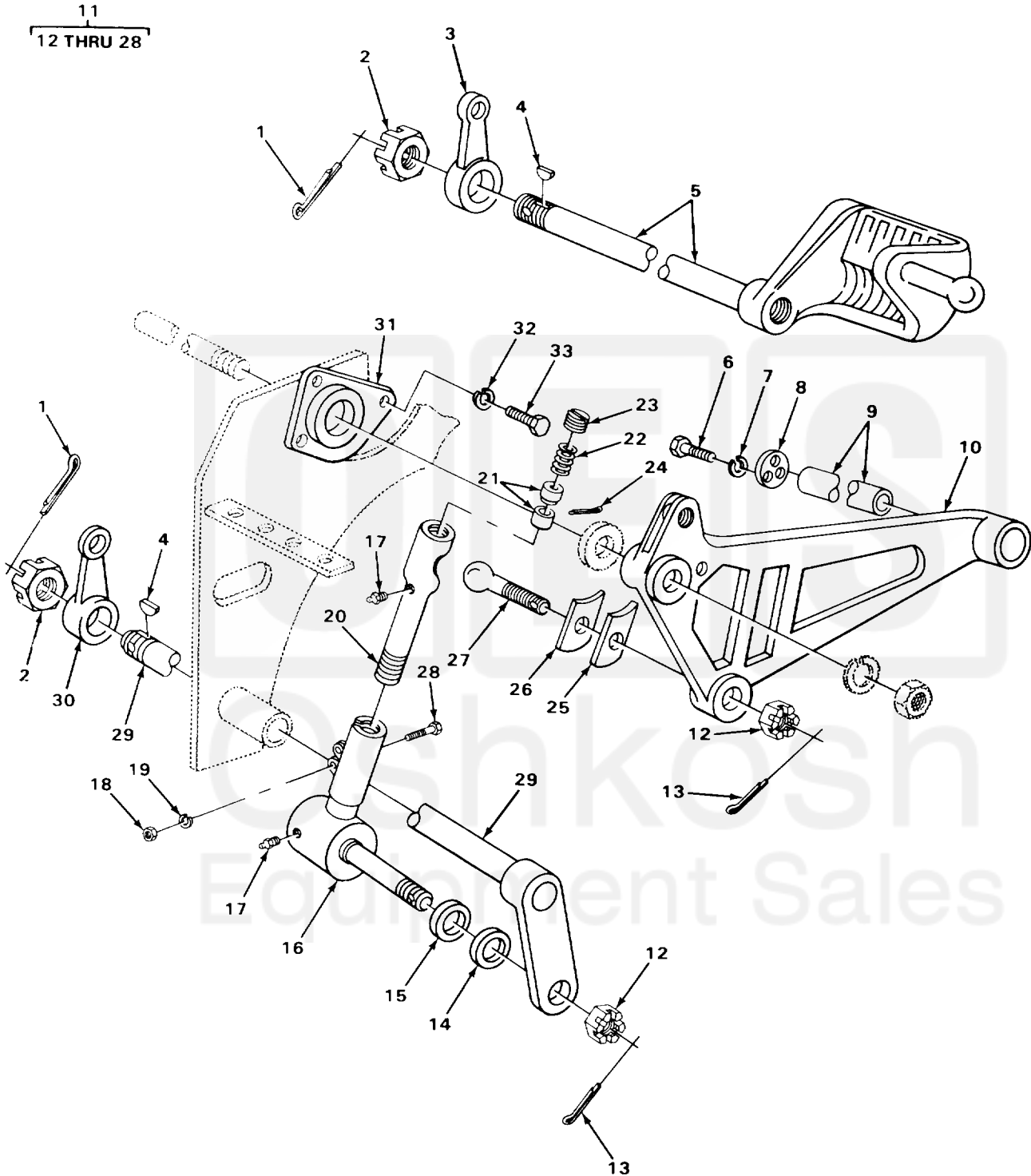

TA705459

FIGURE 133. STEERING LINKAGE.

Current part is item (11) on diagram. Available at [www.oshkoshequipment.com](http://www.oshkoshequipment.com)

ITEM NO	SMR CODE	CAGEC	PART NUMBER	DESCRIPTION AND USABLE ON CODES (UOC)	QTY
GROUP 1401 MECHANICAL STEERING GEAR ASSEMBLY					
FIG. 133 STEERING LINKAGE					
1	PAFZZ	96906	MS24665-357	PIN,COTTER STEERING SHAFT NUT UOC:CQK,U72	2
1	PPFZZ	96906	MS24665-353	PIN,COTTER TIE ROD UOC:CMQ,CMQ,U73,U74	2
2	XDFZZ	97403	13212E4250	NUT,PLAIN,SLOTTED,H ARM RELAY,REAR	2
3	XDFZZ	04285	W69099	ARM,RELAY REAR STEERING UOC:CQK,U72	1
3	PAFZZ	03677	LT1-337	LEVER,REMOTE CONTRO UOC:CMQ,CMQ,U73,U74	1
4	PPFZZ	96906	MS35756-114	KEY,WOODRUFF SHAFT ASSEMBLY	2
5	PAFZZ	04285	W69016	LEVER SHAFT ASSEMBL	1
6	PPFZZ	96906	MS90728-2	SCREW,CAP,HEXAGON H RETAINER PLATE MTG UOC:CQK,U72	3
6	PPFZZ	96906	MS90728-5	SCREW,CAP,HEXAGON H RETAINER PLATE UOC:CMQ,CQK,U73,U74	3
7	PPFZZ	96906	MS35338-44	WASHER,LOCK RETAINER PLATE MTG	3
8	XDFZZ	04285	S69049	PLATE,RETAINER UOC: ,CQK,U72	1
8	PPFZZ	03677	LT1-424	PLATE,RETAINING,BRA UOC:CQK,U73,U74	1
9	PPFZZ	96906	MS17795-152	BEARING,SLEEVE	1
10	PAFZZ	03677	LT1-1815	ARM,PITMAN STEERING	1
11	XAFFF	72210	D20949	SOCKET ASSEMBLY FRONT STEERING LINKAGE UOC:CQK,U72	1
11	PAFZZ	02627	LT1-752	TIE ROD STEERING UOC:CMQ,CMQ,U73,U74	1
12	PAFZZ	72210	S18578	.NUT,PLAIN,CASTELLAT	2
13	PAFZZ	96906	MS24665-359	.PIN,COTTER SOCKET ASSEMBLY UOC:CQK,U72	2
13	PPFZZ	96906	MS24665-353	.PIN,COTTER SHAFT NUT UOC:CMQ,CMQ,U73,U74	2
14	PAFZZ	72210	S18575	.COVER,DUST	1
15	XDFZZ	72210	S18576	.COVER,DUST SOCKET	1
16	PAFZZ	72210	S7509	.TIE ROD END,STEERIN LINKAGE	1
17	PAOZZ	96906	MS15003-3	.FITTING,LUBRICATION SOCKET ASSEMBLY UOC:CQK,U72	2
17	PAOZZ	95879	9018840	.FITTING,LUBRICATION SOCKET UOC:CMQ,CMQ,U73,U74	2
18	PPFZZ	96906	MS51972-7	.NUT,PLAIN,HEXAGON SOCKET ASSEMBLY	2
19	PPFZZ	96906	MS35338-50	.WASHER,LOCK CROSS	2
20	XAFZZ	72210	D18552	.SOCKET	1
21	PAFZZ	72210	13274D	.SEAT,BALL SOCKET	2
22	XAFZZ	72210	S18584	.SPRING,HELICAL,COMP SOCKET COMPRESSION	1

Current part is item (11) on diagram. Available at [www.oshkoshequipment.com](http://www.oshkoshequipment.com)